

## Kemble - Fireside Chair

Product Code: RR05072

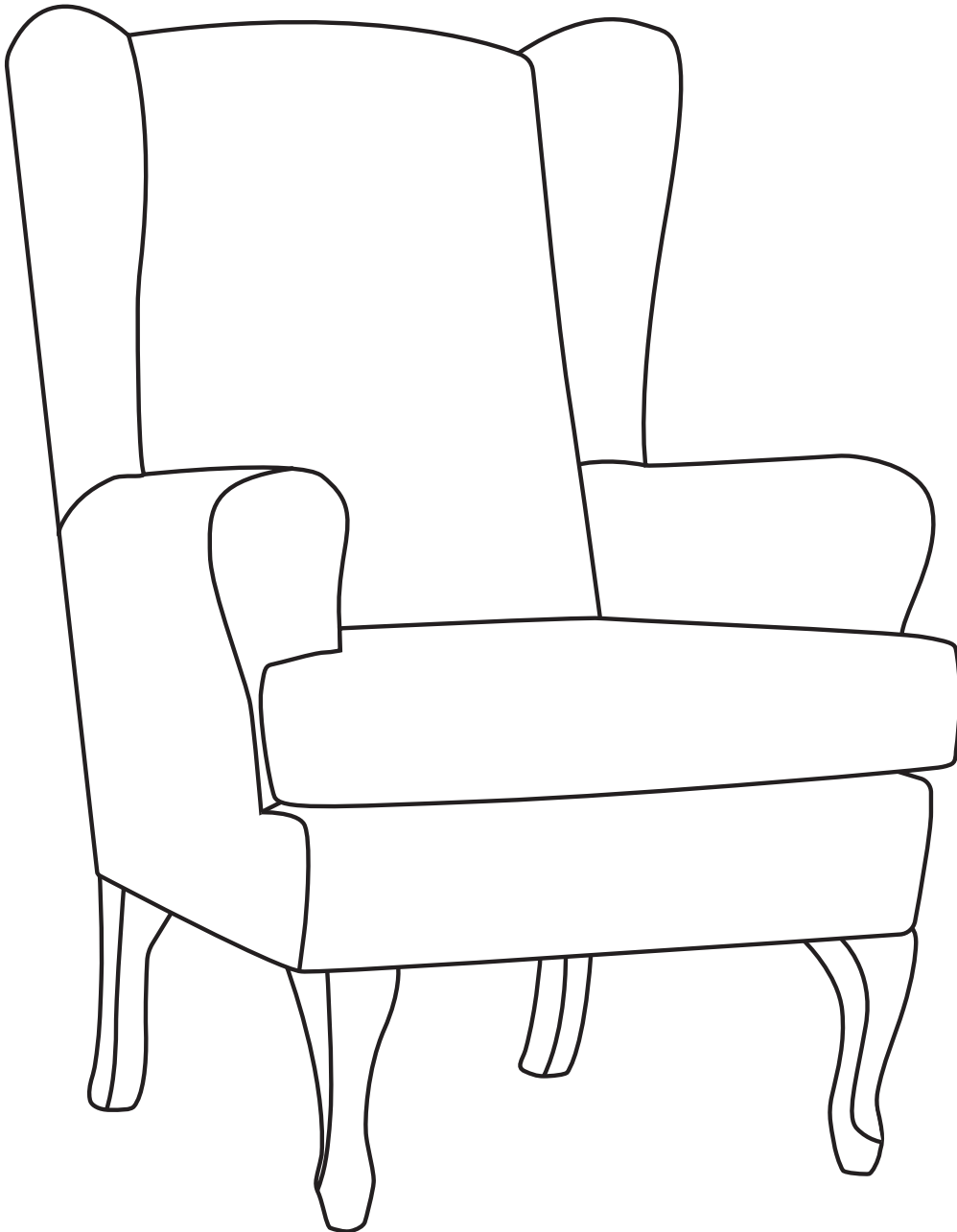

2 Person Assembly



Dimensions - H108 x W77 x D81cm  
Max User weight - 115kg (18st)

## Before Assembly

### Warnings:

- Keep this instruction manual for your reference.
- Only use and assemble this product on level ground.
- Keep all small parts out of reach of children and animals.
- Do not position your chair in front of radiators, fires, or direct sources of heat.
- Do not stand on this product.

### ✓ Do's

- Make sure you have all the components, fixtures and fittings listed in this manual .
- Remove all packaging and ensure you have the correct tools.
- Assemble the product in a clean dry area with plenty of space.
- If possible, assemble the product in the area which you intend to use it, preferably in the same room.
- Carefully follow each step in the correct order to prevent incorrect assembly.
- Before use, ensure that the product is fully assembled as illustrated and all screws are fully tightened.

### ✗ Don'ts

- Don't discard any packaging until the product is fully assembled to avoid disposing of any parts.
- Do not use power tools to construct this product.
- Do not tighten screws until the product is fully assembled.
- Do not over-tighten screws and/or bolts.
- Do not use or attempt to assemble this product if parts are missing, damaged or worn.

## Component & Fittings Checklist

①

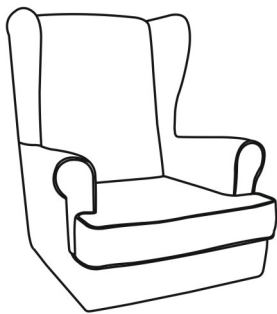

②

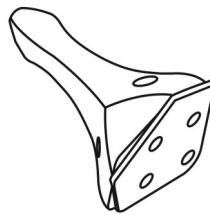

③

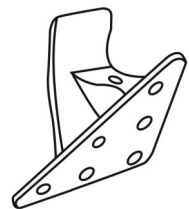

④



⑤

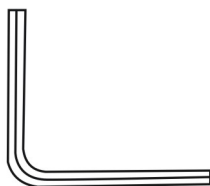

## Assembly Instructions

1.

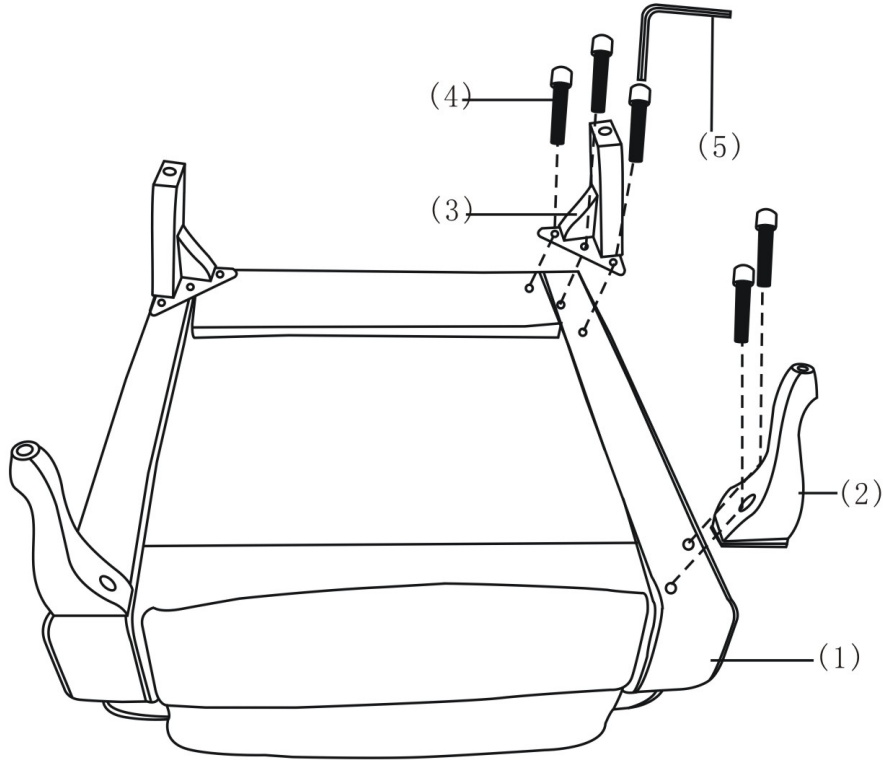

2.

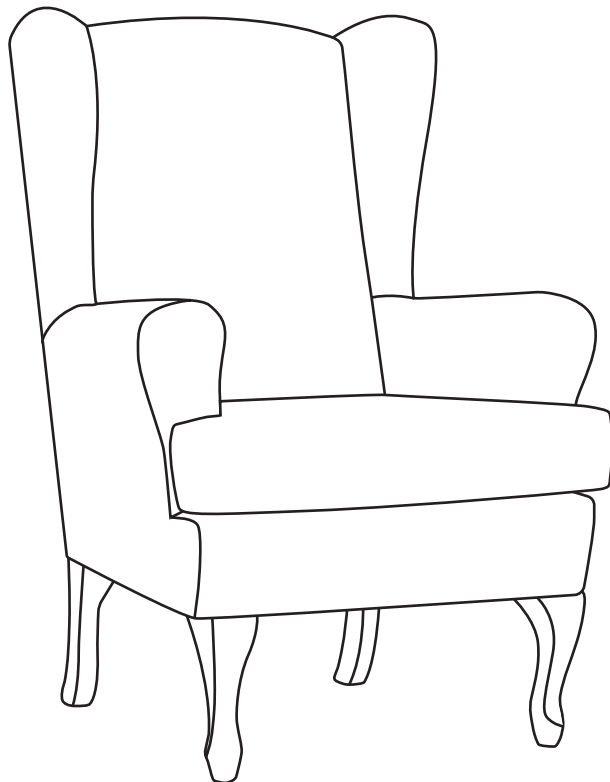

## Care & Maintenance

- Dust regularly with a dry cloth.
- Wipe clean with a damp cloth.
- It is not recommended to use furniture polish or sprays for cleaning.
- Spillages should be removed immediately using a damp cloth, then dried thoroughly.
- Do NOT use abrasive or chemical cleaners.
- Always use heatproof place mats or coasters to protect the surface.
- Periodically check bolts and fixings, tighten if necessary.

## Warranty

Your CareCo branded product is under warranty to be free from defects in material and workmanship for one year from date of receipt. This warranty expresses our confidence in the workmanship and materials used for our products.

In the event of a defect covered by this warranty, CareCo will, at our discretion, replace the product or supply parts to remedy. This warranty does not cover device failure due to owner misuse or negligence, or due to normal wear and tear. The warranty does not extend to non-durable parts which are subject to normal wear and tear and require periodic replacement.

If you have any queries please contact CareCo.

The manufacturer reserves the right to alter without notice any weights, measurements or other technical data shown in this manual. All figures, measurements and capacities shown in this manual are approximate and do not constitute specifications.